

SolaraShade™

Shades that inspire.

INSTALLATION GUIDE

Cathedral

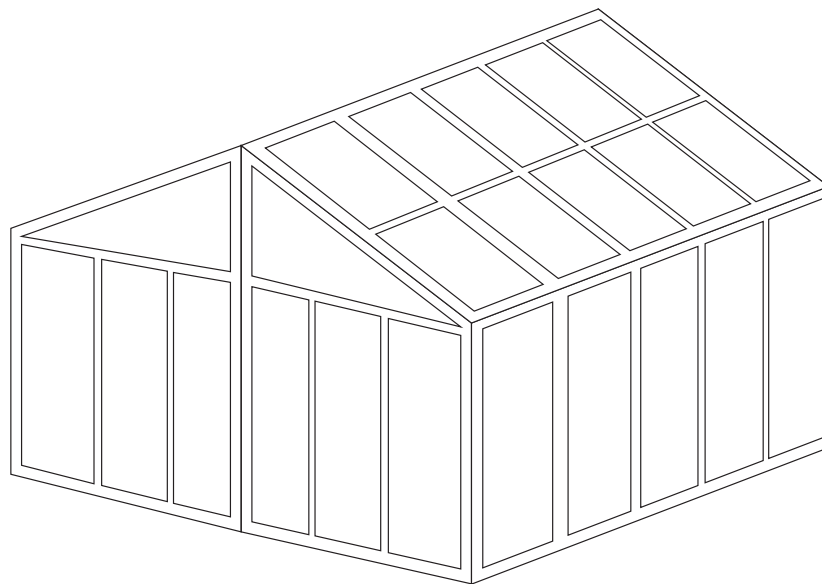

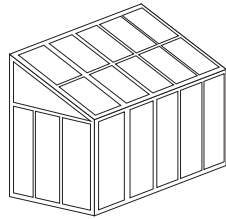

SolaraShade™
Straight

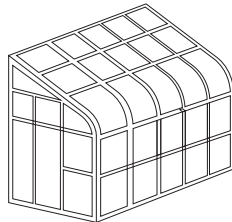

SolaraShade™
Curved

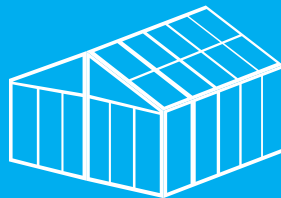

SolaraShade™
Cathedral

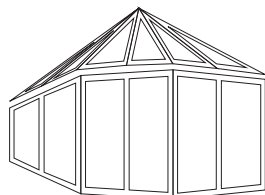

SolaraShade™
Conservatory
Rectangle & Triangle

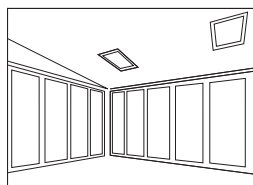

SolaraSky™
Skylight

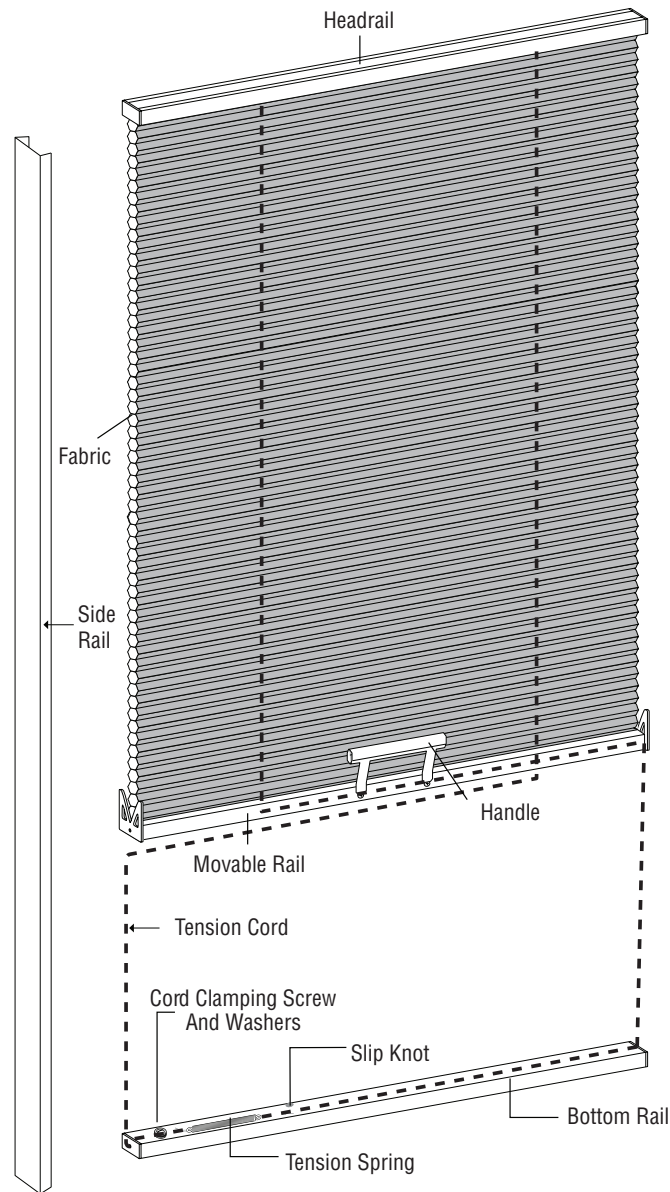

Expanded Hardware Diagram

-
- 1.) Cut tracks to proper length.
(Deduct 1/4" off glass opening)



-
- 2.) Fasten the track into the glazing bar.



-
- 3.) These are the brackets used to fasten the headrail to the top of the sunroom.

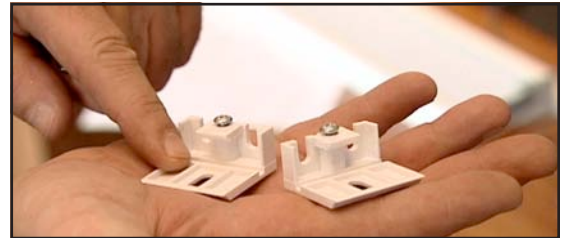

-
- 4.) Back off the screw so that the headrail can be "snapped" into position.



-
- 5.) Align the back of the bracket to the back of the side track.

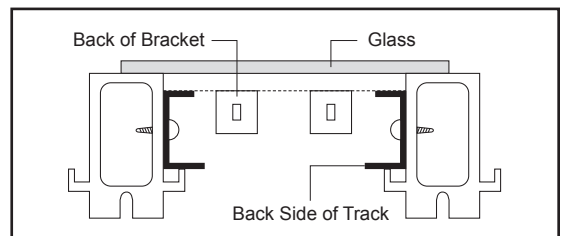

6.) Fasten brackets.



7.) Attach handle to movable rail.



8.) Be sure the cords are not tangled.



9.) Cradle in the bottom rail so it lays flat.



10.) Make sure the cords exit the movable rail end caps properly. (No Tangles)



11.) Click the shade into the side tracks on a slight angle.



- 12.) Push the headrail so that it seats itself into the installation brackets.

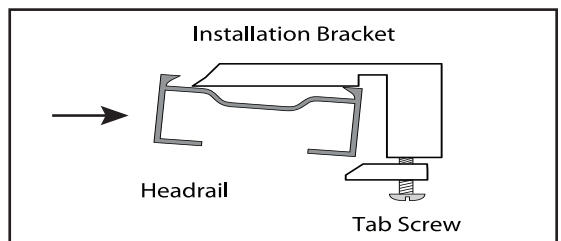

- 13.) Use a Phillips screwdriver to tighten the headrail into the brackets.

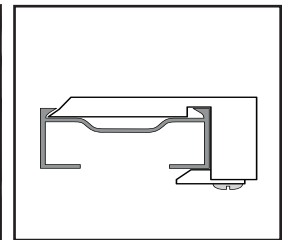

- 14.) Temporarily remove filler strip and fasten the bottom rail into the sunroom with wood or metal screws.



- 15.) Make sure bottom rail is perfectly centered in between the two side tracks.

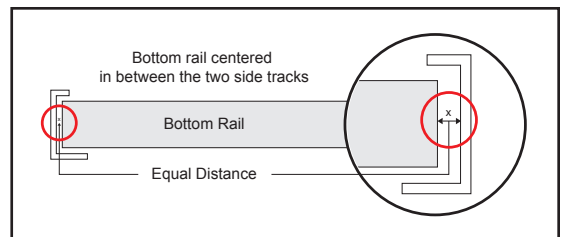

- 16.) Loosen slip knot. Pull string to apply slight tension on to spring. Spring should be stretched by about 1/2". Retie the knot.

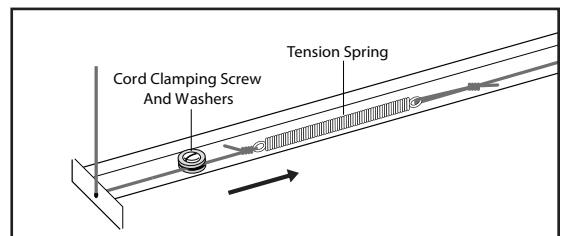

- 17.) Back-off the set screw to allow adjustments to movable rail. Lower shade to ensure movable rail sits flat on bottom rail. Slowly lift shade handle while holding down cord with index and middle fingers. Double check movable rail so that it is parallel to bottom rail. Tension set screw.

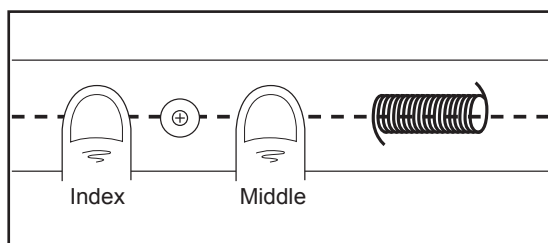

- 18.) Double check the movable rail level.

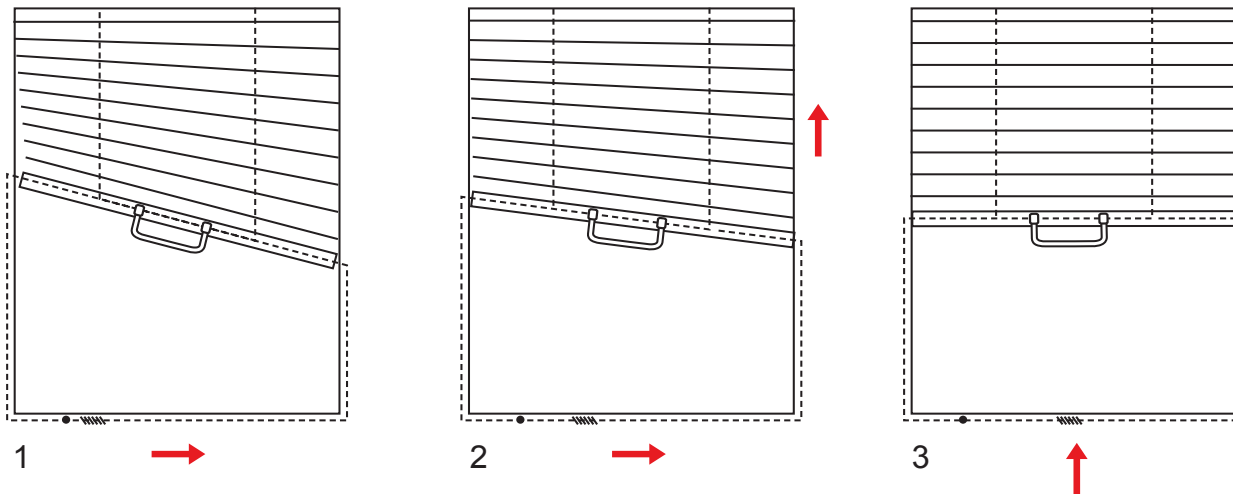

- 19.) Prepare bottom filler strip to conceal bottom rail.



.....
 20.) Insert filler strip back into bottom rail to cover the internal hardware.



.....
 21.) Use detachable telescopic wand to operate shade.



Trouble Shooting

	Problem	Solution
A	The shade does not raise and lower evenly.	<ul style="list-style-type: none"> • Check the installation brackets. Make sure the shade fabric is not caught between the bracket tab and the headrail. • Adjust the cord tension (see step 17). • Check that the lift cords are not pinched or tangled.
B	The shade headrail will not fit into the mounting brackets.	<ul style="list-style-type: none"> • Make sure the mounting brackets are level. Loosen the tab screws slightly and in correct position (see step 5).
C	Shade is too stiff to easily travel open or closed.	<ul style="list-style-type: none"> • Reduce tension on spring.
D	Shade is too loose and will not hold its upper position.	<ul style="list-style-type: none"> • Add tension on spring.

Care and Cleaning

Honeycomb shades are made of an anti-static, dust-resistant fabric which repels dirt and dust. For most honeycomb fabrics, the following options are available if your shade needs cleaning.

DUSTING

Regular light dusting with a feather duster is all the cleaning that is needed in most circumstances.

VACUUMING

Use a hand-held vacuum with low suction for more thorough dust removal.

SPOT-CLEANING

- Prepare a solution of warm water and a mild detergent.
- Dampen a clean cloth in the solution and wring it out.
- Dab the spot with the dampened cloth until it is gone. Do not rub the fabric.
- Allow the shade to dry in the completely lowered position.

DEEP CLEANING

- Immerse the shade in a basin or bathtub filled with a mild detergent. Never immerse the headrail into the solution.
- Rinse with clean water.
- Fully raise the shade and tilt to eliminate excess water.
- Reinstall the damp shade, lower it, and let it dry completely.

ULTRASONIC CLEANING

Some honeycomb fabrics can be ultrasonically cleaned by a professional.

- Specify that a mild detergent solution be used.
- Never immerse the headrail into the solution.
- Dry the shade completely in the lowered position.

www.solarashade.com



3206 Yonge Street, Toronto, Ontario M4N 2L2 Tel: 416-488-6600 1-866-BRADING (272-3464) www.bradingfabrication.com